

# ESTIMATION OF THE ENDURANCE OF RAILWAY VEHICLE CONSTRUCTIONS DEPENDING ON TIME AND VEHICLE'S SPEED

Zoran Čekerevac, Nadežda Šubara<sup>1</sup>

---

*Abstract: The paper presents a method for effective stress characteristics defining while the evaluation of fatigue toughness is practiced. Correlation between fatigue lifetime, function of spectral density and the exponent of S-N curve is given. The method could be applied in various forms of spectral densities. The analysis of interdependences between dynamic loads, toughness characteristics and the railway structure fatigue life-time is shown on the example of an electric powered train.*

*Key words: fracture design, crack development, endurance, railway vehicles*

## 1. INTRODUCTION

In materials science, **fracture toughness** is a property which describes the ability of a material containing a crack to resist fracture, and is one of the most important properties of any material for virtually all design applications. Fracture Mechanics gives a possibility to study cracks and crack-like defects with a view to understanding and predicting the cracks' growth tendencies. The growth may be:

- Stable, relatively slow and safe or
- Unstable, virtually instantaneous and catastrophic.

Fatigue is recognized as a mechanism of crack growth terminated by catastrophic fracture - hence the S-N diagram which may be used to predict failure. If this could be understood, and if the fundamentals of the crack growth process and the interaction between the factors which affect it were formalized mathematically, the onset of catastrophe could be predicted more confidently - rather than having to rely upon a somewhat contrived correlation between S-N curves, notch sensitivity, stress concentration and the like.

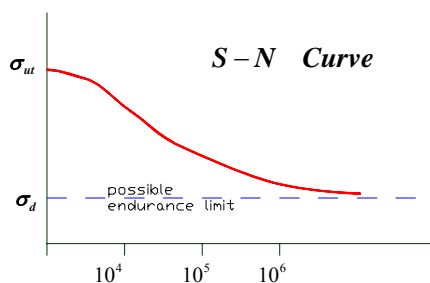

Fig. 1 Fatigue of ductiles

---

<sup>1</sup> Professor Zoran Čekerevac, PhD, Railway College, Zdravka Čelara 14, 11000 Belgrade, Serbia, Tel. +381 64 12-97-97-5, Fax +381 11 3076926, E-mail: [zoran.cekerevac@vzs.edu.yu](mailto:zoran.cekerevac@vzs.edu.yu)  
Professor Nadežda Šubara, PhD, Railway College, Zdravka Čelara 14, 11000 Belgrade, Serbia, Tel. +381 64 270-32-53, Fax +381 11 3076926, E-mail: [nadezda.subara@vzs.edu.yu](mailto:nadezda.subara@vzs.edu.yu)

But this is not the only advantage! There are many well documented catastrophes which cannot be explained by conventional steady state safety appraisal or fatigue arguments. Fracture Mechanics currently offers the only satisfactory route to understanding these and similar problems.

Fatigue breakage appears mostly gradually, when the stresses are in the zone of plastic strains. After the breakage, on the surfaces there is a noticeable slow advance of crack front area through “tree rings” started by crack initiator. Initial microscopic cracks at the very beginning of the breakage successively grow up, but this is still a safe phase of exploitation characterized by slow, controlled, extensions. This phase ends by forming of visible fatigue crack. In the following phase, crack develops with simultaneous increase of stress in remained ligament. Fast catastrophic failure ends process of crack propagation. This area is characterized by transverse granular cleavage surface.

**2. ESTIMATION OF FATIGUE ENDURANCE**

Designing of the endurance under criterion of damage accumulation follows the foregone analyses of contiguous states connected with a production technology, material fracture toughness and it’s ability to withstand crack propagation, stoutness loosing etc. It is also necessary to accomplish the analysis of indicators which determine material states during life time of construction elements. Interaction of a stochastically variable external load and solidity of the considered machine element could be defined by determination of a damage degree. For this purpose, a different hypothesis about the accumulation of damages could be applied. Essentially, this is a function which connects life-time external load changing and remained strength of the element.

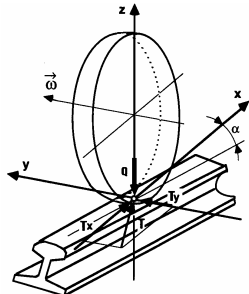

Fig. 2 Contact wheel-rail

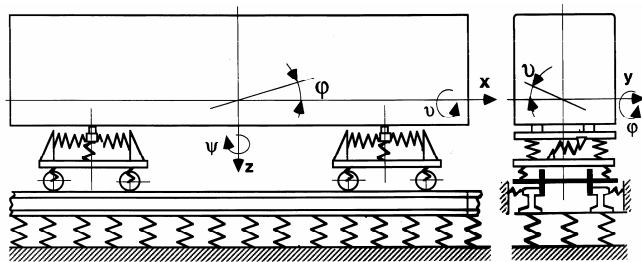

Fig. 3. Model of the oscillating of a mechanical system of the railway vehicle

A railway vehicle steady supported steel wheel movement over elastic steel rails is characterized by a variety of internal and external loads that cannot be fully taken into account even in the same vehicle series. Great number of elements and degrees of freedom of a mechanical oscillating system and variety of working loads are factors that make analysis difficult and disputable. The influences of vehicle speed, speed changing and duration, and speed distribution are emphasized. Also, distortions as well

as wear and tear of infrastructure elements during the exploitation are specific and hardly predictable so they could be only generalized. A few examples are shown in Fig. 4 and Fig. 5.

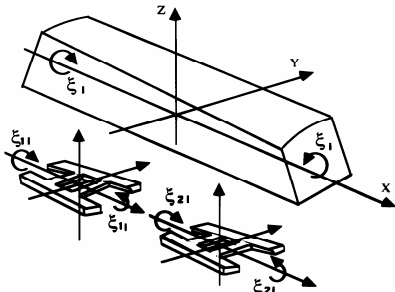

Fig. 4 Torsion of carriage and frames

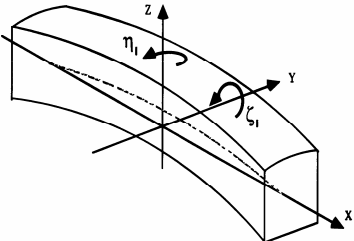

Fig. 5 Carriage bending

Here will be analyzed a method for effective stress characteristics defining while the evaluation of fatigue toughness is practiced. The method could be applied in various forms of spectral densities. For the analysis of interdependences between dynamic loads, toughness characteristics and the railway structure fatigue life-time, until the first visible fatigue crack appears, records of a vertical accelerations of bearing house of an electric powered train (Fig. 6) and a spectrum of dynamic loads of bogie-frame member at the speed of 145 km/h (Fig. 7) are used.

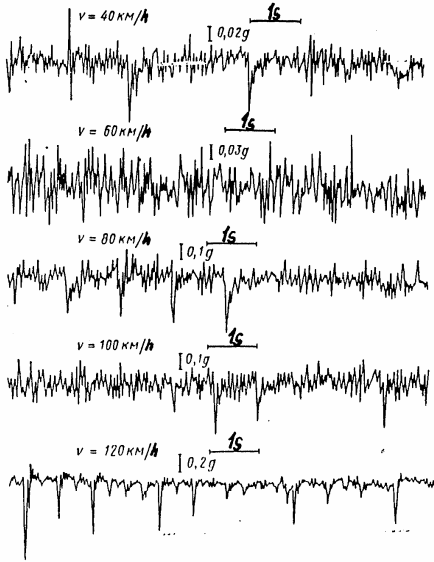

Fig. 6 The record of a vertical accelerations of a bearing house of the electric powered ЭП11 train

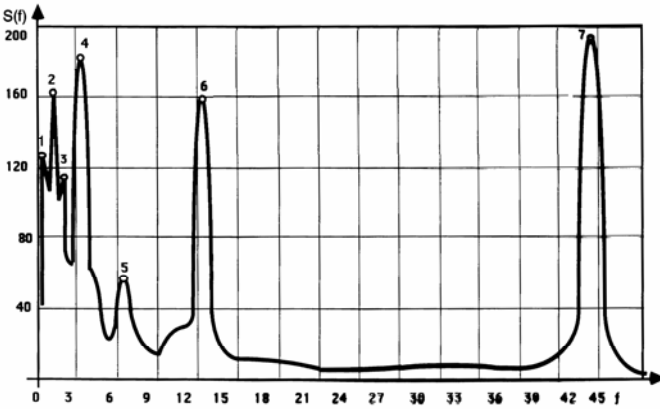

Fig. 7 The spectrum of dynamic loads of bogie-frame member of an electric powered ЭП11 train at the speed of 145 km/h in the zone of the flange of the driving engine

- $S(f) \left[ \frac{(10^5 \text{ Pa})^2}{\text{Hz}} \right]$  - Spectrum density
- $f$  (Hz) - Frequency

The goal is determining of equivalent symmetric or asymmetric sinus regime of load in dependence of the parameters of stochastic dynamic load. Such parameters are:

dispersion, dispersion area wideness, distribution of maximums, a shape of the function of spectral density etc.

The record of vertical accelerations of a bearing house of the electric powered ЭР11 train, shown on Fig. 6, shows that under the change of train speed from 40 to 120 km/h accelerations were increased more than five times. Impulses recorded on the joints of rails are sharp. Speed increasing from the level of 60 km/h to the level of 100 km/h makes the accelerations 3.3 times bigger, and increasing from 100 to 120 km/h makes the acceleration 2 times greater. A fact is that rail vertical resistances are of a random character. They could be described by spectrum density of low frequency accelerations of non-suspended masses of the railway vehicles and they are not depending on springs. Nevertheless, only provisionally they could be characterized as Gaussian processes, because with the increasing of speed in the observed range of high frequencies, probability densities incline to be asymmetric and with sharper picks. By calculating of railway vehicles structure element life-times it is necessary to take into account velocity changes and a probability of appearance of specific speeds.

On the figure 7 it is noticeable that acceleration maximums are:

1. 0.7 Hz – maximum caused by lateral displacement of the body;
2. 1.6 Hz – maximum caused by a wheelset skipping from the rails;
3. 2.2 Hz – maximum caused by matching of the own frequency of the bogie frame acceleration, and it appears by specific constant speed in longer period only;
4. 3.25 Hz – maximum caused by the combination of skipping and rolling of wheelsets over rails (galloping). It appears by variety of frequencies appeared on the rail joints;
5. 6.5 Hz – maximum of the own frequency of the bogie frame;
6. 12 Hz – maximum caused by the rolling of the steel wheels over the rails;
7. 41 Hz – maximum caused by the rotors of the driving engines.

Spectrum of dynamic loads of free rotation bogies (trailers) of the electric powered ЭР11 train at the section of the bogie-frame member is similar to above stated, normally, with exclusion of maximum frequency No.7. The analysis emphasizes the complexity of the spectrum shape with a lot of maximums. The energy of the analyzed spectrums is situated in the wide range of frequencies, 0.5 to 50Hz, and the spectrum wideness is  $\varepsilon = 0.6$  to 0.9. This characterizes random wide band stress processes. The most important are peaks of narrow bands because they influence material structures independently of their durations. Calculations show disparity among estimated life-times up to ten times.

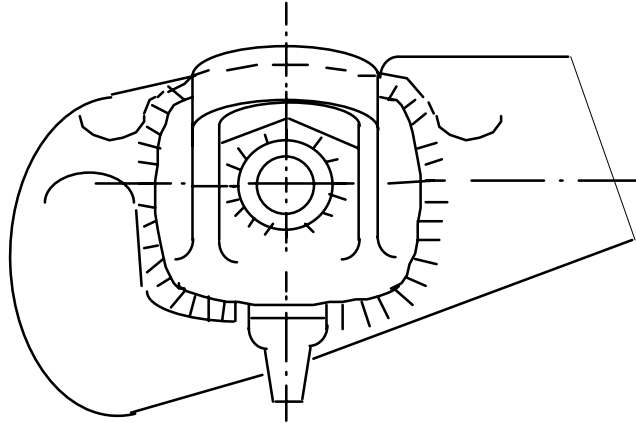

Fig. 8 Connection of a cross-bearer with a welded gear train bearer of the electric powered ЭР11 train

It is possible to compare passed route of the train before the appearance of the fatigue crack on the cross-bearer in the zone of welded gear train bearer with the life-time determined by the mathematical model formed on the bases of the equivalent stationary regime, but with summing of damages that appear on every registered speed.

$$\sigma_{ek} = \sqrt[m]{\frac{2^{m/2} \cdot \Gamma\left(\frac{m+2}{2}\right) \cdot T_0 \cdot f_0}{N_0 \cdot \varphi^m} \cdot \sum_i^i S_{v_i}^m \cdot p_{ti}}$$

where are:

$\sigma_{ek}$  - amplitude of the equivalent stationary narrow stress band;

$m$  - exponent of S-N curve (Wöhler curve);

$\Gamma$  - gamma function;

$T_0$ [s] - Fatigue life-time until the crack appears;

$f_0$  - frequency maximum;

$N_0$  - Basic cycle number until the crack appears under stationary load regime with  $\sigma_{ek}$  amplitude;

$\varphi$  - Coefficient:  $\varphi = \frac{(\sigma_v - \sigma_m)}{\sigma_v}$ ,

$\sigma_v$  - yield strength;

$S_{v_j}$  - dynamic stresses variance under the speed  $v_i$ ;

$p_{ti}$  - probability of the apperiance of the speed  $v_i$ :  $p_{ti} = \frac{p_{li}}{v_i \sum_i^i \frac{p_{li}}{v_i}}$

where are:

$p_{li}$  - probability that train will run in the speed ranges  $\Delta v_i = v_{i+1} - v_i$  for the equal parts of the passed route  $p_{li}$  in kilometers;

$v_i$  - train speed in the  $i$  - breach.

Table 1 [2] shows  $p_{ti}$  values for the train exploitation in suburban traffic:

*Table 1 Train speed probability in a suburban traffic*

Velocity breach $\Delta v_i = v_{i+1} - v_i$ [km/h]	< 40	41-50	51-60	61-70	71-80	81-90	91-100	101-110	111-120	121-130
Probability $p_{ti}$	0.155	0.10	0.11	0.14	0.14	0.14	0.13	0.07	0.01	0.005

The amplitude of the equivalent stationary narrow stress band  $\sigma_{ek}$  has to be corrected by the coefficient of safety  $\eta$  (for railway vehicles usually 1.15) in accordance with the relation:

$$\sigma_{ek} = \left( \frac{[\sigma_{-1k}]}{[\eta]} \right)^m$$

where  $\sigma_{-1k}$  is a minimal fatigue strength of material for a given probability  $q$  on the base cycles number  $N_0$ . By using the previous equations it is easy to define a safe life-time of the structure elements, until the appearance of the first crack, in hours:

$$T_0 = \frac{\left( \frac{[\sigma_{-1k}]}{[\eta]} \right)^m \cdot N_0 \cdot \varphi^m}{3600 \cdot 2^{m/2} \cdot \Gamma\left(\frac{m+2}{2}\right) \cdot f_0 \cdot \sum_i S_{vi}^m \cdot p_{ti}} \quad [h]$$

For expressing the safe life-time in kilometers,  $L_0$  [km], an expected mean speed value of the railway vehicle motion,  $v_m$  [km/h], could be applied in cases when  $T_0$  is defined previously, as:

$$L_0 = T_0 \cdot v_m \quad [km]$$

These equations comprehend the exploitation on different speeds and give possibilities for comparison with the fatigue laboratory testings.

On Fig. 9 several functions of spectral densities of the stresses in the region of the welding joint of the gear train bearer are shown. Exponent S-N curves ( $m$ ) and minimal fatigue strength of material, ( $\sigma_{-1k}$ ), based on the trust coefficient of 0.95 and lab testing of six examples, were determined as  $m=4.15$  and  $|\sigma_{-1k}| = 120$  MPa, while static stress was at the level of  $\sigma_{st} = 320$  MPa. The model shows that, under the speed of  $v = 50$  km/h, appearance of the crack caused by load could be expected at approximately 5% bogie frames after the first 65,000 passed kilometers. The real exploitation data of 20 motor carriages exploited in different regions, tells that the first noticeable fatigue cracks appeared after 150,000 passed kilometers. Calculated values for fatigue lives give reserves of approximately 2 times.

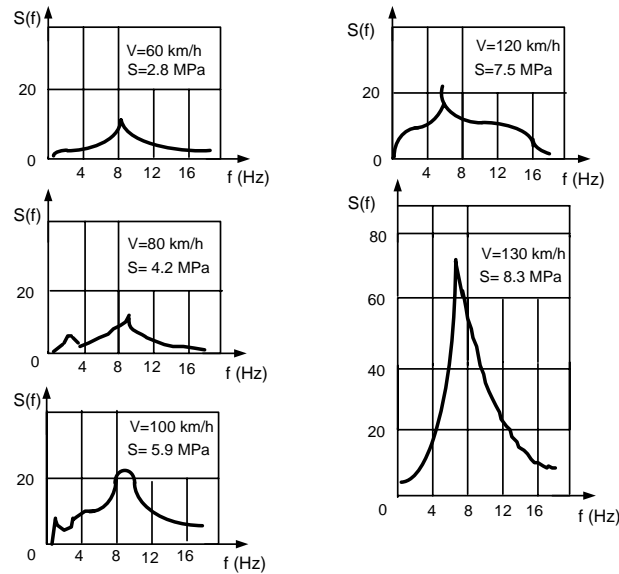

Fig. 9 Specters of dynamic loads of the welding joint

$$\text{of the gear train bearer } S(f) \left[ \frac{(10^5 \text{ Pa})^2}{\text{Hz}} \right]$$

Those results are good enough for project making and material lab testings. For the maintenance purposes the model could be used more successfully if the data base was greater and more precise.

### 3. CONCLUSION

Presented methods for real stress characteristics determining while an estimation of railway vehicle construction fatigue fracture toughness is to be estimated gives a possibility to connect fatigue life, spectral density functions and the exponent of S-N curves. There is, also, a possibility for applying of the model on the loads that give very different spectral density stresses. Taking into the consideration the high frequency load component influences on the fatigue life could give results that differ from the practical results notably.

### 4. LITERATURE

- [1] Šubara N, *Zamor i procena veka šinskih konstrukcija*, Monografija, ISBN 86-7244-355-1, Zadužbina Andrejević, Beograd, 2004.
- [2] Гусев А.С, *Сопротивление усталости и живучесть конструкций при случайных нагрузках*, Москва, Машиностроение, 1989.
- [3] Glumac S, Čekerevac Z, ..., *Projektovanje proizvodnja i eksploatacija autobusa*, Monografija, ISBN 86-902425-2-X, IKARBUS AD, Beograd, 2002.

Recenzent: doc. Ing. Zdeněk Dvořák, PhD.  
Žilinská Univerzita v Žilině